



CENTER FOR
ANTI-VIOLENCE
EDUCATION

ANNUAL REPORT

July 1st, 2022 - June 30th, 2023

TABLE OF CONTENTS

1	ABOUT CAE
2	WHO WE ARE
4	A WORD FROM OUR BOARD CO-CHAIRS / A WORD FROM OUR EXECUTIVE DIRECTOR
6	OUR YEAR
8	IMPACT
10	DEMOGRAPHICS
12	PROGRAMMING
16	PROGRAMMING: EMPOWERMENT SELF-DEFENSE
20	PROGRAMMING: UPSTANDER
22	PROGRAMMING: YOUTH POWER
31	WORKPLACE PROGRAMMING
32	FINANCIALS
33	OUR SUPPORTERS



ABOUT CAE



Our Mission

The Center for Anti-Violence Education (CAE) works to prevent, disrupt and heal from hate violence in our communities through educational programs that center the experiences of the most marginalized people among us.

Our Vision

CAE envisions the world we want to live in as an ever-expanding community of Upstanders, actively working to uphold the humanity and well-being of the collective, especially the most vulnerable among us.

Our Approach

To CAE, anti-violence means that each one of us is safer when all of us are safer.

Our Work

Each year, CAE works with approximately 3,000 New Yorkers, teaching Empowerment Self-Defense to those at high risk of hate violence and Upstander tools to those seeking to make their communities safer for everyone, particularly the most vulnerable among us. We develop and deliver workshops, training and long-term programs that link individual safety and well-being to the safety and wellness of our broader communities. Since our founding in 1974 as Brooklyn Women's Martial Arts, we have trained over 80,000 people in NYC and beyond.

WHO WE ARE

STAFF

Alexis Cariello
Director of Programs

Anees Hasnain
Program Manager, Upstander

Bianca Rhea
Anti-Violence Educator & Advisor

Christine Ratnam
Human Resources Consultant

Emily Ramirez
Instructor, Upstander

Georgina Pierre-Louis
Program Manager, Youth PACT

Grey Cohen
Instructor, Empowerment
Self-Defense

Jasmín Duran
Youth Leadership Program
Coordinator

Jenelle Salem
Operations Coordinator

Jenn White
Bookkeeper

Jenny DeBower
Program Consultant

Jon Diep
Development Manager

Keanu Jackson
Senior Program Instructor, Upstander

***Loren Miller/ Rama Issa-Ibrahim**
Executive Director

Lorraine LaPrade
Instructor, Empowerment
Self-Defense

Rae Switlick
Program Manager, Empowerment Self-Defense

Silvia Hernandez
Janitor

Stevie Triano
Coordinator of Evaluations and Development

*Rama Issa-Ibrahim became CAE's new Executive Director in September 2023 during a planned leadership transition.

BOARD OF DIRECTORS

David Barbee — Co-chair
Managing Director
J.P. Morgan

Kate Lee Butler — Co-chair
Chief Content Officer
Golden Peak Media

Monica Reyes-Grajales — Secretary
General Counsel &
Chief Compliance Officer
Titan Advisors

Nick Molloy — Treasurer
Head of Finance
Street Smarts VR

Bianca West
Founder, Creative Director
21 Degrees West

Caitlin Heffernan
Vice President
Macquarie Group

Frederic Krieger
Senior Counsel
Stradley Ronon Stevens & Young, LLP

Liz Michaud
SVP & CIO
NBC Universal Media, LLC

Marcus Wilson
Senior Vice President
Platform Operations
Dynasty Financial Partners

Michelle Crutchfield
Director & Assistant
General Counsel
Bank of America

Sheila Wellington
Retired
*Stern School of Business
& CEO Catalyst*

Simon Rice
SVP Solutions Architecture
Direct-to-Consumer
NBC Universal Media, LLC

From The Co-Chairs of the Board of Directors:



Kate Lee Butler, Co-Chair



David Barbee, Co-Chair

This last year has felt momentous. After a remote homebase since March 2020, The Center for Anti-Violence Education opened a new office at the YWCA in Downtown Brooklyn - a significant break from four decades in CAE's Park Slope home. CAE also increased in-person programs while retaining virtual options to keep anti-violence resources accessible to those who need them most and we increased full-time staffing beyond pre-pandemic levels. The board and staff worked closely to raise funds through our first major in-person gathering since Covid-19, the joyous Spreading Love Through Laughter Comedy Night. And we completed year one of our bold three-year strategic plan to expand community driven leaders towards an ever-growing wave of Upstanders against Violence.

On the horizon in 2024 is CAE's 50 year anniversary. A sobering reality that large- and small-scale violence is pervasive. But also a source of great hope that everywhere around us, people are seeking to learn ways to prevent, disrupt and heal from hate violence. CAE has grown from a dedicated cadre of women in its earliest years to a broad community that in the past year engaged 4,380 people across NYC and the US in learning Empowerment Self-Defense for those at high risk and Upstander strategies so that bystanders to violence are better equipped to intervene. CAE delivered more than 160 workshops, community conversations and training sessions for adults and young people. And partnerships with more than 80 community organizations, schools, workplaces, and public institutions across the boroughs were what made it possible. One particular highlight of the power of these partnerships to expand the reach of our efforts, is the work that CAE's Self-Defense Team did with New York Theater Workshop, leading to their production of "How to Defend Yourself," addressing sexual assault and prevention on college campuses. You will see the scope of this work and more examples in the pages ahead.

The moment of this writing also marks an inflection point. We are delighted to welcome CAE's incoming Executive Director Rama Issa-Ibrahim, who comes to CAE with over a decade of experience in the anti-violence movement and deep passion for gender-justice and public safety for communities at risk. At the same time, we are sorry to say goodbye to ED Loren Miller, whose passion and persistence led CAE through the pandemic and surge in hate violence. We thank her and wish her well on her journey.

As hate violence persists, so do requests for CAE's anti-violence programs. Your support fuels our work and we are deeply grateful for it. As donors, you can be confident that your generosity will directly support program operations and that even small donations make a difference.

Thank you for being part of our work toward a more peaceful and just world.

From the Executive Director:



Loren Miller, Executive Director

Dear Friends,

CAE's organizing principle has long been to actively build the world we want to live in. And in the last year, more and more I'm hearing folks in our communities talk about possibilities, like what if instead of violence and fear as the norm, the standard was a community of care? And, what would it look like to have a community that cares for people at risk and in distress? What would it feel like if there were always people out there who had our backs?

When I reflect on the past year and the intensity of anti-violence work, at the myriad ongoing challenges of life made harder by hate violence, what rises is gratitude to all the people in CAE's communities and beyond who persist in their efforts to link individual safety to the well-being of the collective.

On May 17, CAE held our biggest in-person event since Covid-19 sent us remote. It was Spreading Love Through Laughter, a Comedy Night to raise funds for our work with communities targeted by hate violence. We raised 10% of our annual budget - strengthening our capacity to deliver Empowerment Self-Defense and Upstander programs to over 4,000 young people and adults in NYC and across the US. And the evening was joyous! It was an uplifting and inspiring cacophony of people seeking to build more caring ways of being together.

As many of you know, I have been preparing these last months to step down from my position as CAE's ED. CAE's new Executive Director, Rama Issa-Ibrahim, began September and we worked for several weeks together on a transition. Transitions are hard but Rama comes to CAE with deep roots in the anti-violence movement. She is someone that CAE, and I personally, have worked with in past years and someone with a powerful vision for this moment. So keep an eye out for what's to come.

Thank you for being part of our efforts and making this work possible.

OUR YEAR

“How do we normalize care as a crisis response, rather than violence?”

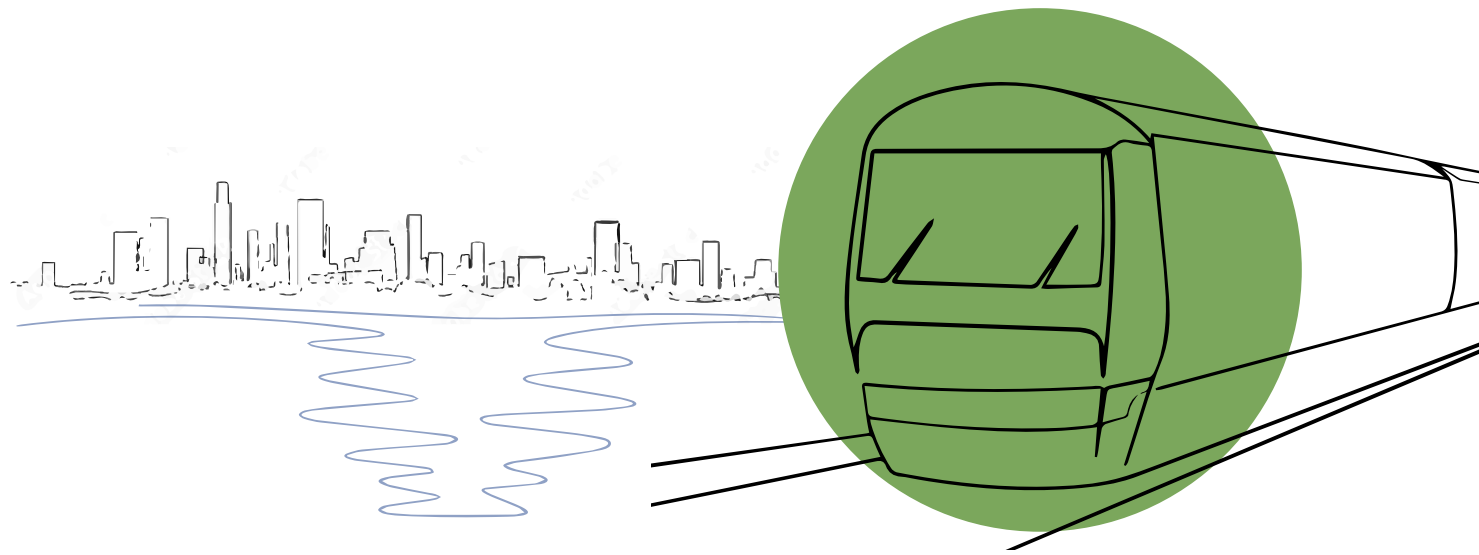

On May 1, 2023, Jordan Neely, a 30-year-old Black man, was killed on the subway by Daniel Penny, a 24 year-old white former marine who placed Neely in a chokehold. Neely was a singer and dancer, known by many subway riders. On this day, Neely spoke out loud and with anguish from the middle of the subway car about the issues he was facing as a result of homelessness and poverty. Penny perceived this as threatening.

The tragic loss of Jordan Neely left many in mourning, and in horror and disgust that we are **a society where murder is considered a justifiable response**. Where a man in a desperate state is seen as disposable.

This incident surfaced critical questions: **how could this have been prevented? What could bystanders have done in the moment? And how do identity and our own personal experiences influence each of our reactions for personal safety?**

CAE's **response was to collaborate with partners** from Jews for Racial and Economic Justice (JFREJ) and the New York Civil Liberties Union (NYCLU), creating a space for community members to **process this violent incident together** in an open conversation at the Museum of Broken Windows. Participants to this event mourned and engaged in a wide ranging conversation around targeted violence, the lack of funding for mental health services, crisis as an unmet need and how to offer support to neighbors who are in distress. The event culminated with a skill share around de-escalation skills. The key **takeaway was the imperative of normalizing care to community members rather than violence**.

Subsequent Upstander workshops across NYC brought up complex questions around **what Upstander looks like in public spaces, the assumptions we might be making about others and questions around our responsibility to one another**. Others discussed the compounding violence that led to that moment and the dehumanization of Black community members.



IMPACT

CAE developed and delivered workshops, training and programs that linked individual safety and well-being to the safety and wellness of our broader communities.

We did this work so that....

People at high risk of hate violence are better equipped to keep themselves safe.

98% of Empowerment Self-Defense training participants said they learned new tools/strategies.

We can help build communities of care as a foundation for safety and anti-violence.

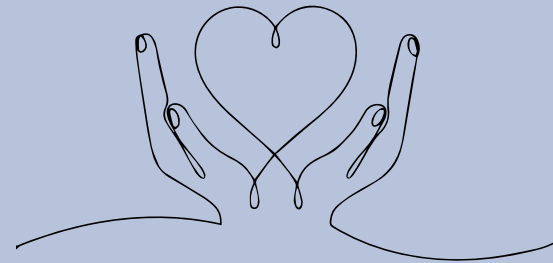

Anyone – whether they are a target of hate violence or not – is better equipped to understand and address systems of oppression.



Anyone – whether they are targets of hate violence or not – is better equipped to intervene in incidents of hate violence against others.

84% of participants to Upstander programs stated there was at least one thing they would do differently now.

“I will feel more prepared and confident when I move through the world. Hopefully I won’t have to use these techniques but under threat I will have actual defense strategies.”



DEMOGRAPHICS

Race/Ethnicity

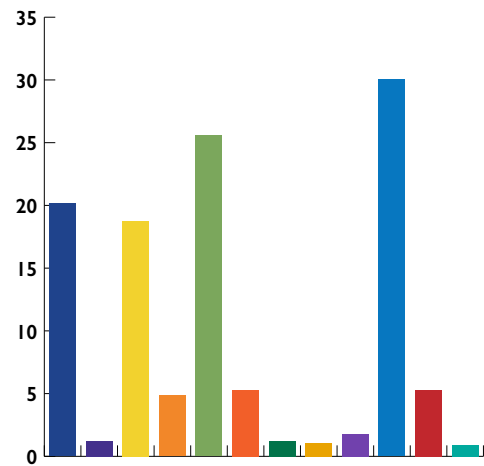

 20.14% African-American/Black/African Descent
 1.22% Arab/Arab American
 18.74% Asian/Asian-American/Asian Descent
 4.86% Caribbean/Caribbean American
 25.56% Hispanic/Latinx
 5.31% Jewish
 1.20% Middle Eastern
 1.05% Native American/First Nation
 1.78% South Asian/South Asian American
 30.03% White/Caucasian/European Descent
 5.31% Mixed race/Multi-racial
 0.90% Self Identify

Gender

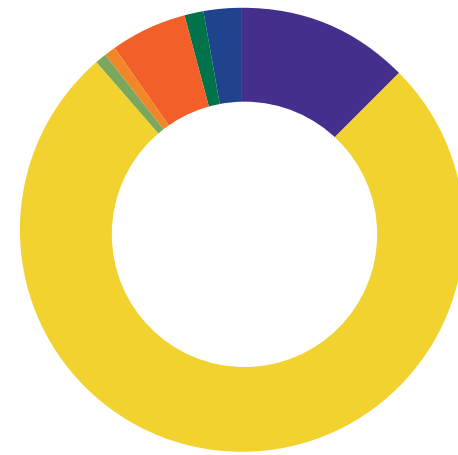

 12.62% Man (Cisgender)
 76.17% Woman (Cisgender)
 0.83% Man (Transgender)
 0.91% Woman (Transgender)
 5.59% Non-binary/gender non-conforming + Trans*
 1.21% Unsure/questioning
 2.70% Self-Identify

Age

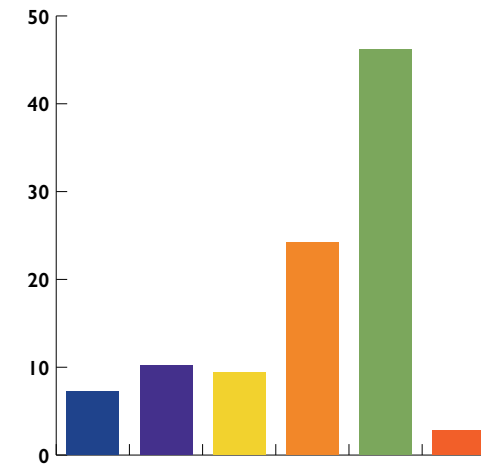

 7.26% 10-15
 10.18% 16-19
 9.38% 20-24
 24.20% 25-34
 46.22% 35-64
 2.77% 65+

Sexuality

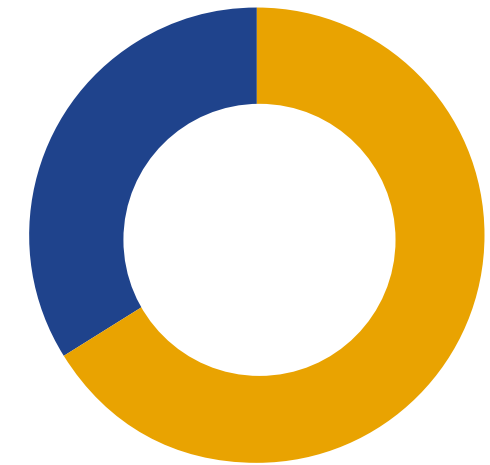

 66.37% Straight
 33.63% LGBTQ+

PROGRAMMING

In this last year, CAE **developed and delivered 160 workshops, training and long-term programs** linking individual safety and well-being to the safety and wellness of our broader communities. We brought these programs to over 4,380 young people and adults within NYC and across the US. Participants learned Empowerment Self-Defense strategies, which included physical strategies based in martial arts, as well as a broad array of verbal, social and emotional techniques. They also learned Upstander tools for disrupting violence towards others, inclusive of de-escalation, active bystander interventions and calling-in strategies. All programming was delivered in a context of community care.

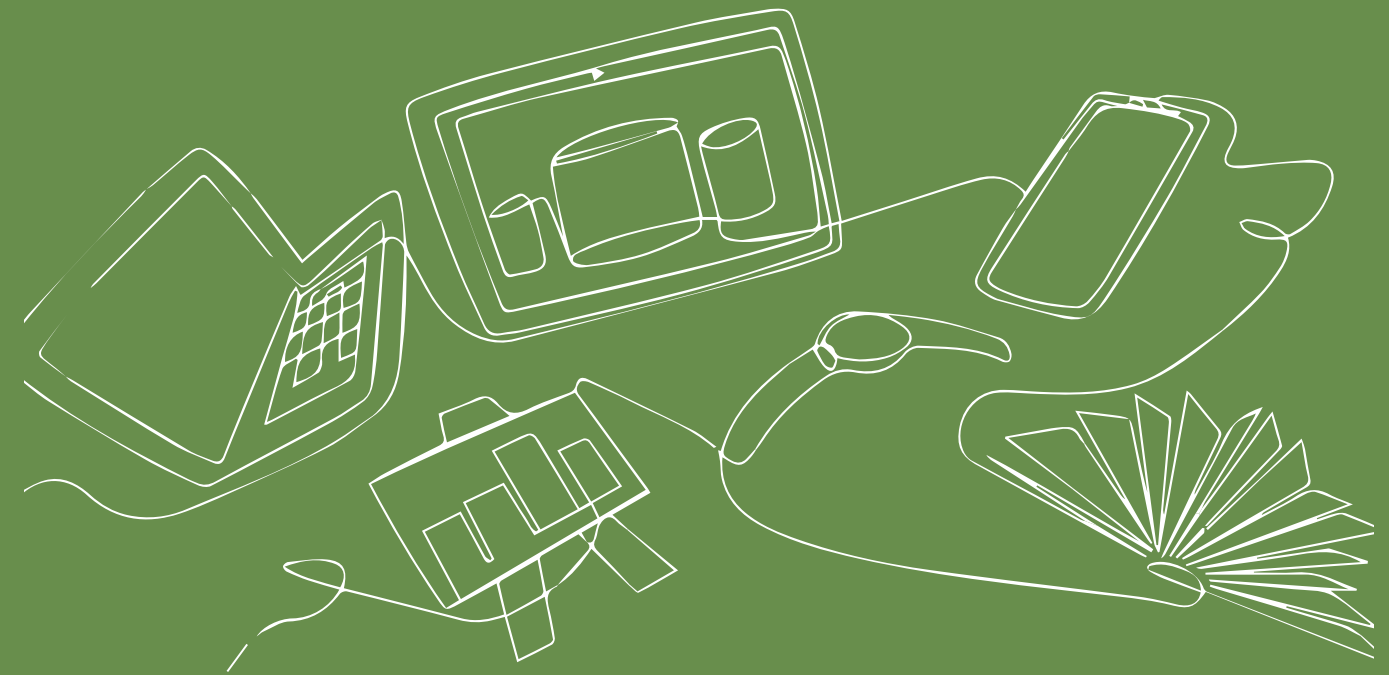

We were able to accomplish so much through partnerships with **over 80** community organizations, schools, social service agencies, shelters, workplaces and community leaders. **Over 75%** of the people CAE served were women, girls, and folks who are LGBTQ+, particularly those targeted by racism and xenophobia. **More than 40%** identified as survivors of violence.

4,380
people gained
anti-violence tools

85%
of participants accessed CAE's
services for free, made possible
from donations and grants

90%
of program participants came
from the five boroughs of NYC

424
of program participants
were youth

11 workshops
were conducted by CAE and High
School Peer Educator Interns

Below, and in the pages that follow, is a breakout of our work into three core program areas: **Empowerment Self-Defense for Adults**, **Upstander Programming for Adults**, and **Youth Power** programs.

“I am more aware of my own instincts so I believe I can now make more rational decisions about my safety. It changed my awareness and capability. I would recommend the class to anyone who is new to self-defense.”

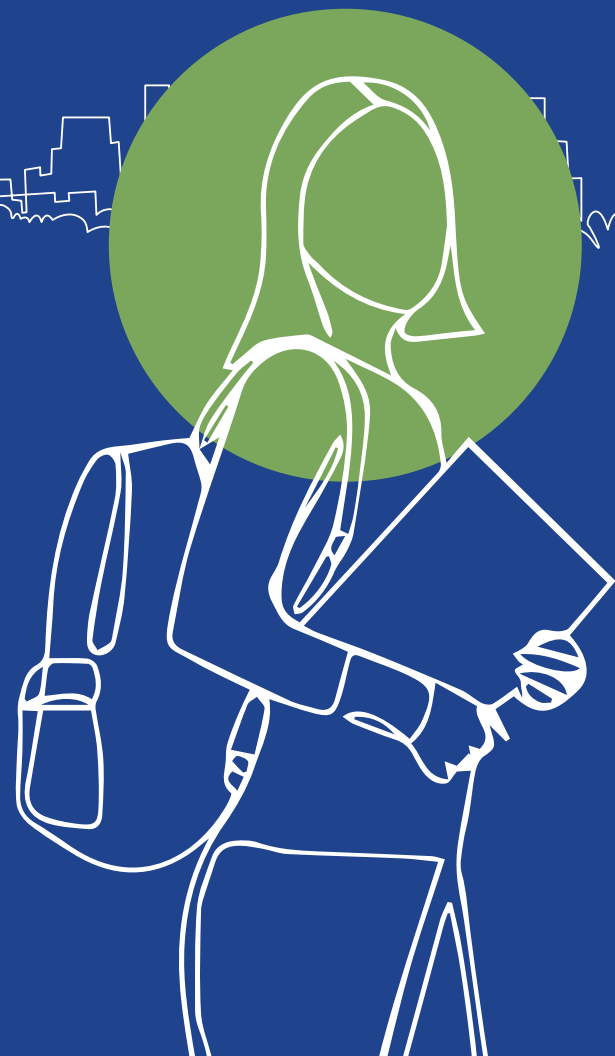

ACTIVITIES WITH ADULTS

- Empowerment Self Defense workshops for workplaces, community organizations, theaters, and senior homes
- Upstander workshops for workplaces, community organizations, neighborhood groups, and faith institutions
- Community Conversations, Monthly Physical Practice, Monthly Community Upstander

ACTIVITIES WITH YOUTH

- Empowerment Self-Defense workshops at schools, community organizations, public housing
- Upstander workshops at schools, community organizations, public housing
- Power Action Change for Teens (PACT) Afterschool Program
- High School Peer Educator Internship

OUTPUTS

- Over **200** Workshops
 - Over **4,000** Participants
 - **80** Groups Partnered with
- Monthly Community Conversations
- **38** PACT participants
- **18** Peer Educator Interns

OUTCOMES

- People are better equipped to keep themselves safe
- People are better equipped to intervene in incidents of hate violence towards others
- People are better equipped to understand and respond to systems of oppression
- People build communities of care around safety and anti-violence

IMPACT

People live safer and more free from violence

PROGRAMMING: EMPOWERMENT SELF-DEFENSE

Over the last year, 2,787 adults ages 25–65+ in NYC and beyond came to CAE with concerns for their safety and deep fear and unease from prior incidents of violence. Beyond personal safety, concerns were also from threats to broader communities at risk, notably people who were elderly and infirm, LGBTQ+ group and women. People came with questions about ways to protect themselves in a range of scenarios and how to safely intervene when situations escalate. Persistent requests were made for public transit safety skills.

CAE's Empowerment Self-Defense programming worked to equip both individuals and communities at high risk of hate violence to keep themselves safer. Workshops, trainings, and practices were designed to teach practical skills, relevant to daily life, in ways that were trauma-informed and accessible to those most at risk. The goal was for participants to leave feeling more empowered to protect themselves, both individually and in groups.

Accessibility was increased by offering programs both in person and online through Zoom. Whether it was one workshop or a five-part series, the

Monthly Community Access Physical Self-Defense Practice

Physical self defense is like any other physical skill — practice helps make folks comfortable. Through monthly practice, instructors and participants joined together to practice core physical self defense skills, to build a community of learners for feedback and partnership, and to regularly learn more specialized techniques in each session. Over the course of the year, 29 adults became a part of this regular community.

majority of participants accessed training through a community organization they belonged to or their workplace. CAE also offered a free monthly physical practice, in which 29 New Yorkers consistently gathered to practice their physical self-defense techniques while also building connections to each other, becoming part of a community and less alone. Participants from self-defense trainings walked away with tangible, actionable skills for safety that were adapted across a variety of abilities, body types and situations.



They gained physical skills and techniques based in martial arts, such as safety stances, footwork, strikes, blocks, and other relevant techniques. They learned situational awareness skills like scanning and boundary setting, de-escalation strategies, and voice work. They also gained new perspectives on social factors that impact safety. Twenty-three workplaces, consisting of non-profits and corporate institutions spanning finance, insurance and banking, called CAE in to address safety fears among individual employees at risk of hate violence, and reported that the experience was a significant team building opportunity.

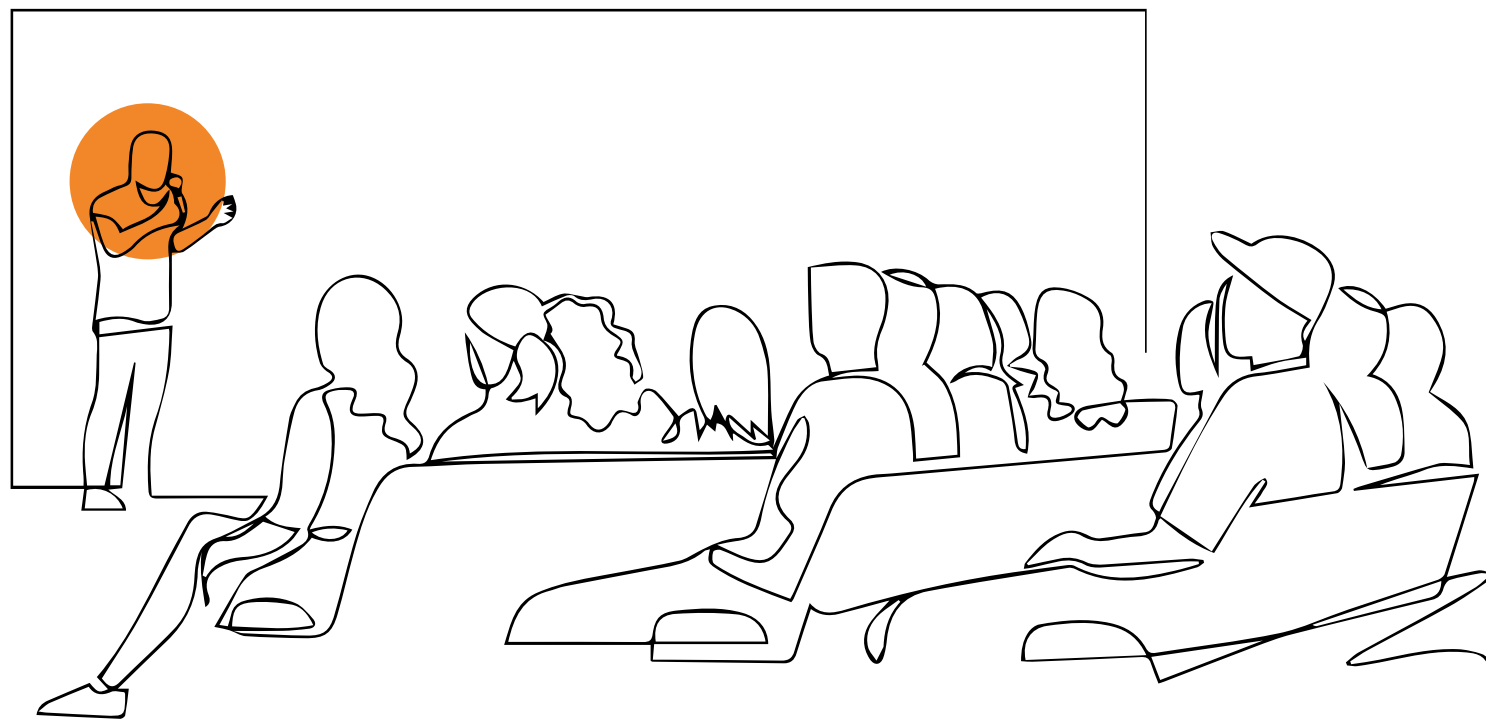

PROGRAM HIGHLIGHT

The Power of Theater

New York Theater Workshop (NYTW), a community of artists and audience members who use theater to better understand the world and affirm our common humanity, brought CAE in as a partner for an upcoming production. Liliana Padilla, who years prior had taken a CAE Empowerment Self-Defense training on what to do if they were threatened, developed the play, *How to Defend Yourself*, which explored responses to and prevention of sexual assault among college students. CAE's Program Manager for ESD, Rae Switlick, served as technical adviser and dramaturg as the play was developed and she and her team facilitated De-Escalation & Safety workshops to NYTW staff, to help them build skills they modeled during the show. CAE staff also delivered 6 workshops to audience members and participated in talkbacks and resource shares round anti-violence efforts inclusive of and beyond Empowerment Self-Defense.

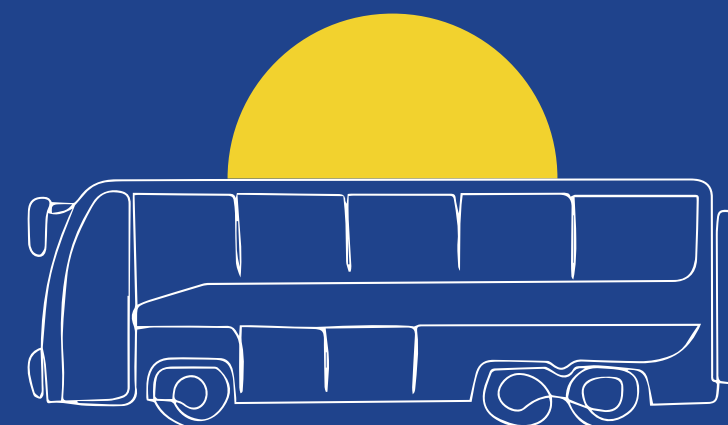

Public Transit Safety Series

CAE's Public Transit Safety Series was a way to unpack the multiple safety issues and fears New Yorkers have been facing when using public transit. CAE's workshops taught ways to help avoid, de-escalate, and address violence on public transit, delivering content in a way that was specific to transit settings and in line with the MTA's current protocols. Introductory workshops were offered to a range of workplaces. Through partnerships with the NYC Commission on Human Rights and Cabrini Immigrant Services and the use of technology, we offered the full series in a trilingual format. In another partnership with the Asian American Federation, it was run as a seven-part series for their constituents within and outside of NYC.

*“They had great, common-sense suggestions [for] when you’re trying to de-escalate a situation that were so smart I felt like I *should* have known them all along.”*



PROGRAMMING: UPSTANDER

“What I gained from today’s workshop was about building a community of WE.”

Participant from an Upstander Workshops

Over the last year, CAE’s Upstander program worked to ensure that anyone - whether they were targets of hate violence or not - would be better equipped to intervene in incidents of violence against others. Implicit to this was preparing participants to better understand the ways systems of oppression reproduce and to build communities of care around safety and anti-violence.

The Upstander team delivered **48 workshops for 1024 adults ages 25–60+** who came looking for ways to actively and safely disrupt incidents of hate violence in their communities. Participants walked away with concrete, actionable tools - including active bystander interventions, de-escalation skills and calling in strategies.

Participants gained a deeper awareness of how systems of oppression contribute to a legacy of violence, of their own positionality across a range of scenarios, and steps to hold themselves and their community members accountable. In response to the pervasive question around, ‘how do I show up for others when I am also threatened?’ CAE Instructors opened conversations with participants



that emphasized violence prevention along with healing and aftercare. Participants envisioned themselves and those they were in the workshop with as in **beloved spaces where — rather than the violence that has become so normalized and commonplace — they could show up for each other, nurture support in their interactions and uplift practices of care.**

Community groups and workplaces sought CAE’s assistance for showing up to conflict in ways that raised standards of community care. Much attention was dedicated to **engaging with conflict as a generative tool, guiding individuals and groups to take steps to repair, restore and transform relationships after an incident of harm had taken place.** Techniques were also taught for instilling emotional safety and aftercare support following an incident of violence.

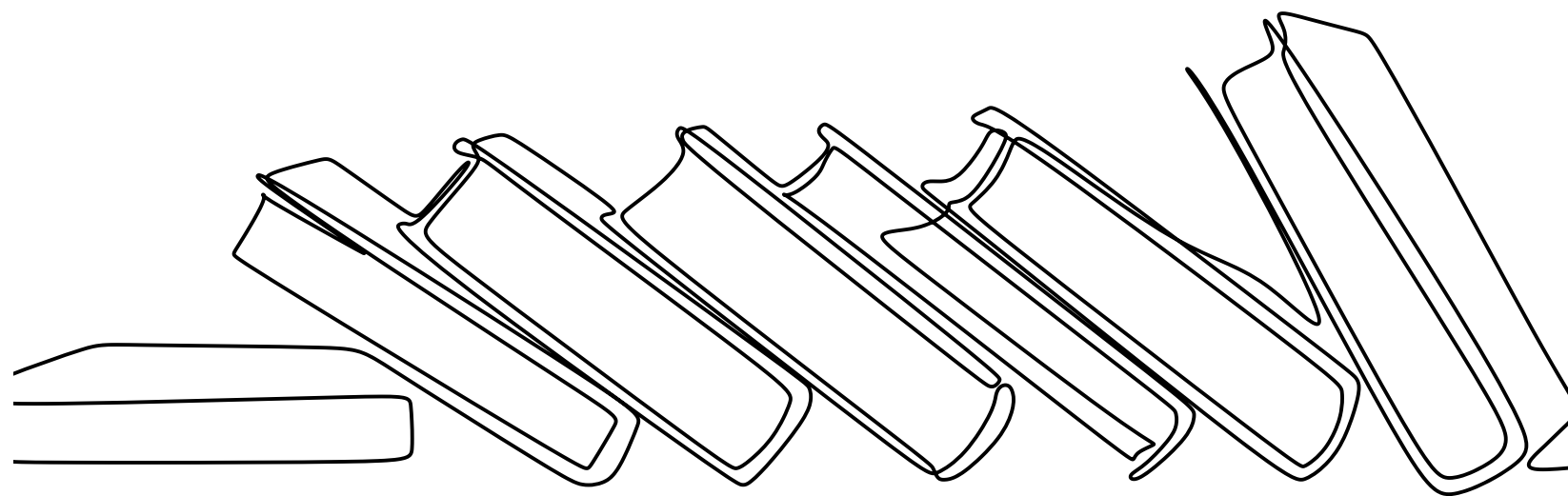

MOVEMENT BUILDING

As part of the Queens Partners Against Hate Coalition, **Voces Latinas** brought CAE in to deliver a two-part Upstander series on community safety and power. Over two days, participants focused on building beloved community, envisioning ideal communities, and **identifying concrete steps to take towards the world we want to live in.** With the space to be together as a coalition, participants were able to **uplift shared values, opportunities for deeper work together, and identify shared language and knowledge** around their work.

PROGRAMMING: YOUTH POWER

Youth Power Leadership Progression

CAE's youth programs served **424 young people** through two year-round programs, multiple outreach events and 11 workshops across NYC. Three core areas of youth power programs are:



Power Action Change
for Teens (PACT)



Peer Educators



Workshops

GUIDING QUESTIONS FOR YOUTH LEARNING

Who is in the room and how are we connected?

What does “anti-violence work” mean?

How am I already practicing anti-violence?

How do I position myself for safety and evaluate for safety?

What are some concrete physical tools I can use to protect myself and others?

How can I use my voice to set expectations, regain control in a situation, or simply ask for help? What are some things that get in the way?

How do I know what my own boundaries are?

How do I respect others' boundaries?

What tangible ways can I say no, or re-negotiate boundaries in an existing relationship? Where can I get help?

Youth Power I: PACT (Power, Action, Change for Teens)

The PACT after school program for girls (cis and trans) and gender non conforming youth gathered 38 middle and early high school young people in a series of four, five-week afterschool cohorts. We were thrilled to welcome them in the Community Room at CAE's new location at the YWCA in Brooklyn. The overarching **goal of this program was to support young people to keep themselves safer.**



Like all CAE youth programs, PACT is grounded in positive youth development practices and **delivered in a context of social enrichment, community building, and emotional support.** Given the pervasive trauma and isolation of the last several years, it was more important than ever to run programs that met young people where they were, crafting spaces for youth to have fun and prosocial experiences with each other. Adolescent and teenage participants experienced what safe felt like in the context of a caring community where the safety and well-being of each member mattered. And they explored the prospect and path to becoming **advocates for themselves and in their communities - whether school, neighborhood, family or friend groups.**

The range of PACT cohorts was designed to provide a holistic introduction to anti-violence ideas, teaching and tools. Young people learned about **healthy relationships** with peers and trusting adults. They also learned **basic Empowerment Self-Defense physical techniques** and had an introduction to **social justice education**. PACT youth showed special interest in learning to communicate more clearly with friends and elders, interrupting interpersonal and dating violence, and exploring consent. Through role playing, activities, and presentations, youth practiced intervention and self-advocacy in real time, and they engaged in creative and art-based activities to reflect on their learning and development.



YOUNG PEOPLE SET BOUNDARIES & EXPECTATIONS FOR THEIR RELATIONSHIPS

PACT programming takes care to focus on the **importance of encouraging youth to use their voice and embrace who they uniquely are in relationships**. The Flower Bouquet activity provided a creative and tactile approach to identifying needs, wants, and boundaries in relationships.

Each participant was given a bouquet of faux flowers wrapped with a ribbon along with strips of paper and safety pins with the prompt: **What are the traits and interactions that you want to have in your relationships?** Youth wrote things like “I want my partner to listen and treat me with respect” and “I want my partner to be a good listener and respect my body and boundaries” and attached their own messages onto the faux flower bouquets.

At the end of the activity, each participant had a visual reminder of their reflections – the key takeaway being that **they decide what they deserve and desire in their relationships**.

“What ‘feels’ right to do as a knee-jerk reaction may not actually be a productive de-escalation tactic (or it might be). I learned to be aware of my positionality and what strategy might work best for everyone involved.”



Youth Power 2: Peer Educators

The Peer Educator program is an internship for high school girls (cis and trans) and gender non-conforming youth who have strong grounding in anti-violence techniques and approaches. They typically come to us from other CAE programs. They are selected as role models, mentors and educators for their peers and go on to teach CAE's youth-facing programs with staff.

Last year's Peer Educator program returned to fully in-person programming for the first time since the pandemic. Their journey launched in July 2022 with an intensive summer training program. Eighteen high school girls (cis and trans) and gender non-conforming youth were selected as trainees. The goal was to prepare them to transition what they knew and understood about anti-violence to becoming educators and instructors on anti-violence for other teens.

Peer Educator trainees went deeper into learning the history and values of CAE's anti-violence work, they built their Upstander and Empowerment Self-Defense skills, and, critically, they grew a community with their peers. Their summer training included fun trips around the boroughs such as Brooklyn Botanical Gardens and The Guggenheim Museum, helping them get to know each other better and get more comfortable exploring and traveling around their city.

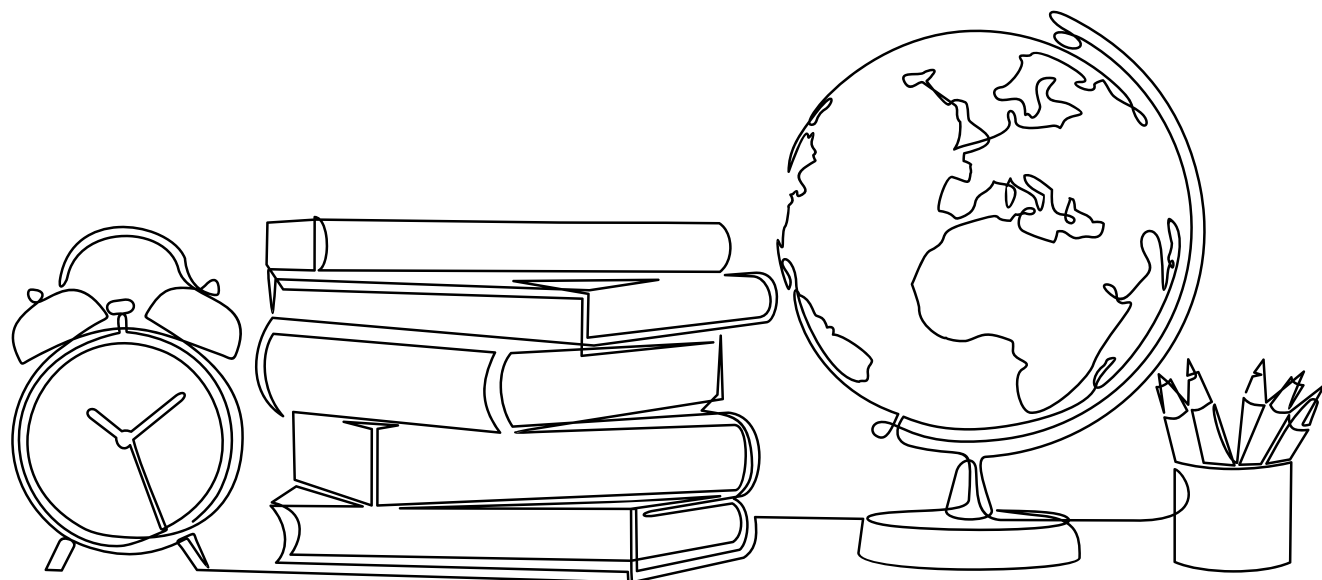

By the end of their training, 100% of Peer Educator Trainees reported that they felt confident in their ability to facilitate groups, and 100% felt more confident in leadership skills than at the beginning of the summer.

Throughout the school year, Peer Educators continued to explore the social and political factors that impacted their daily lives, bringing to light the unique and unprecedented challenges teens have encountered in the past several years. They delved deeper into topics like healthy relationships, systems of oppression, consent, and the impacts of social pressures on mental health and well-being.

News and instances of sex trafficking concerned them and they organized themselves to conduct a year-long research project. Peer Educators brought their findings to a conversation with other High School leaders from the group Toxicity in The City, when they met to discuss ways to make change around toxic relationships.

Out in their communities, Peer Educators taught 11 anti-violence workshops to other young people in schools and community organizations. They also tabled and conducted outreach and self-defense demonstrations.

At the end of the Peer Educator program, 100% of Peer Educators surveyed increased in at least two benchmarks of social emotional learning and 100% agreed or strongly agreed that they have the skills to be politically informed, they have interest in how government works, and they were likely to vote.



Peer Educator Jillian Dudley receiving CAE's Changemaker Award

MENSTRUAL EQUITY PROJECT

Despite 2016 NYC legislation requiring free menstrual products be provided in public schools, there are countless schools and institutions across the city where menstruating teens and adolescents have no access. So when a group of middle school girls approached NYC Council Member Shahana Hanif's office for resources for menstrual products in their schools, the District 39 Office saw the power of these girls as organizers and activists and connected them to CAE. Instead of using participatory budgeting money to buy menstrual products that would eventually run out, CAE's Peer Educator staff guided the now High School Teens in a political and social grounding in menstrual equity. They coached and supported the teen leaders to replicate their middle school activism by training their peers to do the same. This Menstrual Equity Leadership Cohort designed and facilitated three workshops for other teens who wanted to urge their schools to provide period products to girls and people across the gender spectrum.



Youth Power 3: Workshops

Beyond our year-round ongoing programs, **CAE trained 366 youth throughout NYC in 24 workshops in schools and other community organizations.** High School Peer Educators brought their passion to connect with their peers and collaborated with CAE staff to facilitate 11 of these workshops.

Schools and community organizations came to CAE with concerns that their youth seemed to be reverting to physical violence more quickly than in the past and wanted help understanding de-escalation and learning alternative ways to handle conflict. The majority of workshops requested were for CAE's introductory Empowerment Self-Defense training. Young people learned to tap into the power of their voices to set boundaries and de-escalate. They learned techniques for situational awareness, managing physical distance, blocking physical grabs and hits, and striking for defense. The Upstander workshop most requested was "Using Your Superpowers." Youth explored ways they could be Upstanders to disrupt xenophobia and anti-Blackness. They learned safe intervention strategies, including active bystander interventions and delved into the role of media and social media in inflaming prejudice. In all programs, youth learned about aftercare— how to take care of themselves and support others when an incident of harassment or other violence occurred. The AfterCare segment was also used in adult workshops and regularly lauded.

PRIDE

UPSTANDER SQUAD GOALS: PULLING THROUGH FOR OUR QUEER AND TRANS COMMUNITY

In the first two months of 2023 alone, there were over 300 bills targeting LGBTQ+ rights. As a response, CAE delivered open community workshops during PRIDE month for anyone to join. In an effort to disrupt real life scenarios of homophobic and transphobic violence, participants explored tools and strategies for de-escalating conflict and intervening in different scenarios as Upstanders. There were interactive discussions around the differences between gender identity, gender expression, and sexuality, and the roots of transphobic oppression. And participants also learned more about the history of queer and trans people - both their joy and their continued resistance in the face of targeted violence, from the Stonewall Riots to the Stonewall Protests.

THE POWER OF YOUTH WORKERS

Essential to CAE's youth power programming is the capacity building training and support we provide to the dedicated adults across NYC who work with young people. Participants in Upstander workshops for youth workers in schools said:

"I would recommend this workshop to anyone who works in a school to raise awareness about supporting our LGBTQ+ youth."

"It was a great reminder to connect with the guidance staff in the buildings. It was also helpful framing to think of the ways in which we have "agency" in various situations."



Participants in Upstander workshop for youth workers in schools

"I left with more confidence to deal with situations I am regularly put in by working with schools."

"Topics are critical to work being done with youth and families and support in personal life."



WORKPLACE PROGRAMMING

CAE ran 26 workshops for adults at workplaces for the purposes of supporting internal teams. From 19 community organizations to the four corporations that called us in, most commonly requested was de-escalation training, subway safety, and Upstander 101. CAE's customized Fee for Service program trained 270 employees from seven different private institutions - inclusive of universities, insurance companies, tech companies, arts institutions, hospitals, and bookstores.

Whichever workshop was taught — whether Empowerment Self-Defense or Upstander tools, participants consistently said that team building with their colleagues was an additional unexpected outcome of their time with CAE.

"Already recommended it to my mother (who does DEI at a university) halfway through the training."

"I would recommend this training for all folks working in the frontlines of violence intervention work. We have lots of training and skill building to do in the field."



FINANCIALS

FY23 Unaudited Financials

Revenue	
Total	\$1,025,280
Government Contracts:	\$518,500
Grants & Foundations:	\$179,023
Special Events & Individual Donations:	\$204,983
Earned Income Program Revenue:	\$58,300
Government - Payroll Protection Program:	\$0
In-Kind Donations:	\$52,505
Investment return, other:	\$11,969

Expenses	
Total	\$855,195
Program Expenses:	\$612,010
Management & General:	\$134,281
Fundraising:	\$108,904

FY22 Audited Financials

Revenue	
Total	\$992,900
Government Contracts:	\$422,500
Grants & Foundations:	\$154,845
Special Events & Individual Donations:	\$114,977
Earned Income Program Revenue:	\$144,700
Government - Payroll Protection Program:	\$96,575
In-Kind Donations:	\$71,911
Investment return, other:	-\$12,608

Expenses	
Total	\$985,204
Program Expenses:	\$680,477
Management & General:	\$178,146
Fundraising:	\$126,581

OUR SUPPORTERS

We are grateful for every donation we receive from our supporters.
We couldn't possibly do it without you!

\$65,000+

NYC Mayors Office of
Criminal Justice Combat
Sexual Assault Initiative
(CSA)
NYC Mayors Office of
Criminal Justice Prevent
Sexual Assault (PSA) Initiative
for Young Adults
The New York Community
Trust (NYCT)

\$50,000 - \$65,000

Fund for Girls & Young
Women of Color administered
by New York Women's
Foundation
NYC CM Erik Bottcher
District 3
NYC Department of Youth
& Community Development
(DYCD)
NYC Domestic Violence and
Empowerment Initiative
(DOVE) administered by Safe
Horizons
NYC Hate Crimes Prevention
Initiative (HCPI)
NYC Partners Against the
Hate (P.A.T.H.) FORWARD
Initiative administered by the
NYC Anti-Violence Project
(AVP)

\$10,000 - \$49,999

David Barbee
Diane Arber Hirsch
Jeffrey Talpins Foundation in
recognition of Peter Hirsch
Lori Arbeiter and Jennifer
Hobbs
NBCUniversal Media, LLC
Employee Match
NYC CM Crystal Hudson
District 35
NYC CM Shahana Hanif
District 39
Speaker of the NYC Council
Adrienne Adams
The Frank and Ruth E. Caruso
Foundation
Youth INC.

\$5,000 - \$9,999

Caitlin Heffernan
David Russo
Frederic Krieger
HCL Technologies Ltd
Katherine Franke
Kyndryl Inc.
Macquarie Capital (USA) Inc.
Macquarie Capital (USA) Inc. Employee Match
New York Life Insurance Company
New York Theatre Workshop
Optiv Security Inc.
Springer Nature America, Inc.
Stanley Lomangino
The Hyde and Watson Foundation

\$1,000 - \$4,999

Adam Fletcher
American Express Company Employee Fund Match
Andrea Small
Anita Baker
Autumn and Eric Shepherd
Bank of America Employee Match
Brinqa
Centner Financial CPA LLC
Chris and Roshni Cariello
DataStax, Inc.
David Wilhoit
Davis Wright Tremaine LLP
Ernst & Young Global Limited
Fabienne Gimenez
Fine Family Foundation
Gloria and Michael Kadish
Google Employee Match
India Home, Inc.
Jeff Fogel
Jennifer Lee
Jonathan Sullivan
Kate Butler
Kathryn L. Butler
Katie Kelley
Kong Inc.
Lisa Watson
Liz Michaud
Loretta P. Russo Charitable Fund
Lynn Gernert
Mace Blickman
Michael Hirschhorn
Michelle Crutchfield
Nick Molloy
Oracle Cloud Infrastructure
Rebecca Breska
Richard and Marjorie Cariello
Simon Rice
The Bank of America Charitable Foundation
Veracode
Zimperium, Inc.

\$500 - \$999

Abbott Laboratories Employee Match
Anne Taranto
Build America Mutual Assurance
Company Employee Match
Daniel Gillmor
Daniela Feibusch
Farah Tanis
Gabrielle Boodoosingh
Jennifer White
Jessica Fiscina
Jill Greiss
Kevin Chen
Luella T. Russo Charity Fund
Marcus Wilson
Mary Caracappa
Monica Reyes-Grajales
Nadia Telsey
Palamona Ferris
Peachy Myers
Richard Kennedy
Susan McNeill
Theresa Sun

\$100 - \$499

Alaina Heine
Alan Nakagawa
Ana Ivic
Andrew Moss
Andrew Sta. Ana
Barbara Malfucci
Belinda Chan
Benjamin Solum
Bonnie Anderson
Brian Shivers
Britaania Poppie
Cathy Wilkerson
Chitra Aiyar
Christena Wong
Clifton Bartley
Courtney Hartman
Deborah & Dan Duane
Delia Mellis
Diana Daiauri
Diwaker Naman
Donna Schneiderman Drach
Eileen Ryan
Elizabeth FitzGerald
Elizabeth Goldstein
Emma Conniff
Emma Ilise
Eric Mundt
Fran Danis
Fran Davis

\$100 - \$499

Giovanni Casas
 Gregory Freisinger
 Gregory L'o Beau
 Heather Fennell
 Heather Remek
 Jacqueline Cincotta
 Jane Hirschmann
 Janet Rosenzweig
 Javier Medrano
 Jennifer Cook
 Jessica Fiscina
 Jessica Harrington
 Jill Strauss
 Jillian Miller
 Joan Byron
 Jonathan Fried
 Joshua Hiller
 Judith Loebel
 Judy Biener
 Julie Quinton
 Karen Schneider
 Karen Kramer
 Katherine Risbrough
 Kathleen Offenholley
 Laurel Leckert
 Lauren Ramsey
 Lenore Rogan
 Marc Fernandes
 Marjorie Cariello
 Martha Kamber
 Mary Myers
 Mary May
 Matthew Cluney
 Maura Miriam Bairley
 Maura Smale
 Mave Tzall
 Melissa Blaszczyk-Brewer
 Melissa Terzo-Scott
 Micaela Christophe
 Milo Chesnut
 Maira & Peter Madonia
 Nancy and David Gernert
 Nathan Dudley
 Nathan Golan
 Nicola White
 Paul Gootenberg
 Rachel Efron
 Rajdeep Saha
 Robert Miller
 Robin Burdulis
 Rosalie Friend
 Shawn Kennedy
 Shivani Banker
 Steven Strauss
 Susan Boscarino
 Susan Nierenberg
 Tom and Anne O'Reilly
 Tracy Hobson
 Vadzim Dabravolski
 Victoria Law
 Victoria Ruffolo
 Yuka Nishino

\$1- \$99

Alan Poole
 Alexander Franklyn
 Alexander Moore
 Alison Roland
 Ana Capek
 Angeli Rasbury
 Bright Funds Foundation
 Bronwen Houck
 Camila Noronha
 Carl Loof
 Carol Johnson
 Chamandatt Persaud
 Christiana Muntzel
 Dayana Rodriguez
 Deborah Weil
 Dell EMC Employee Volunteer
 Reward
 Dylan Andres
 Emerson Dudley
 Emily Moore
 Farhan Ahmed
 Genevieve Cielo
 Gianne Chen
 Gregory Butterfield
 Gregory Tewksbury
 Heather Elliot
 Jacklyn Boehm
 Jameela Syed
 James Austria

Jane Coble
 Janet Boudris
 Janet Sharma
 Jen Hoyer
 Jennifer Desantis
 Jennifer Hutz
 Jill Warner
 Jincy James
 Jody Pollack
 John Guarino
 Jorge Mamis
 Joyce Williams
 Kaidi Zhang
 Katharine Young
 Katherine Becerra
 Katherine Diwaker
 Kathryn Trotter
 Katy Rubin
 Kei Ng
 Kenneth Kessel
 Kevin Sasala
 Kinjia Hinterland
 Kristian Nistad
 Linda Sarrel and Linda Tyson
 Lisa Mangano and Rodney Abbot
 Lisa Master
 Liza Dube
 Lucia Stoica
 Lynn Carter

Marcia Kirkman
 Mark Enos
 Mary Thompson
 Melinda K. Daniels
 Meryl Allison
 Meryleen Mena
 Nancy Comerford
 Nicalus Franklyn
 Niko Paliouras
 Patricia Crawford
 Paul Stein
 Paul Vergara
 Robert Barnett
 Robert Hesser
 Robyne Walker
 Roseanne Malfucci
 Sara Gould
 Sarah Ooi
 Sheila Wellington
 Silvia Gonzalez
 Stephanie Jones
 Stephanie Nilva
 Tara Witt
 Terry Kong
 Venkat Mahalingam
 Wander Alcaraz Schmidt
 William Bruno
 Yumarie Ortiz Lopez



caeinfo@caeny.org



www.caeny.org



718.788.1775